



RE-AIPMT – 2015 TEST PAPER WITH ANSWER & SOLUTION (HELD ON SATURDAY 25th JULY, 2015)

1. 2,3-Dimethyl-2-butene can be prepared by heating which of the following compounds with a strong acid ?

- (1) $(\text{CH}_3)_2\text{C}=\text{CH}-\text{CH}_2-\text{CH}_3$
 (2) $(\text{CH}_3)_2\text{CH}-\text{CH}_2-\text{CH}=\text{CH}_2$
 (3) $(\text{CH}_3)_2\text{CH}-\underset{\text{CH}_3}{\text{CH}}-\text{CH}=\text{CH}_2$

(4) $(\text{CH}_3)_3\text{C}-\text{CH}=\text{CH}_2$

Ans. (4)

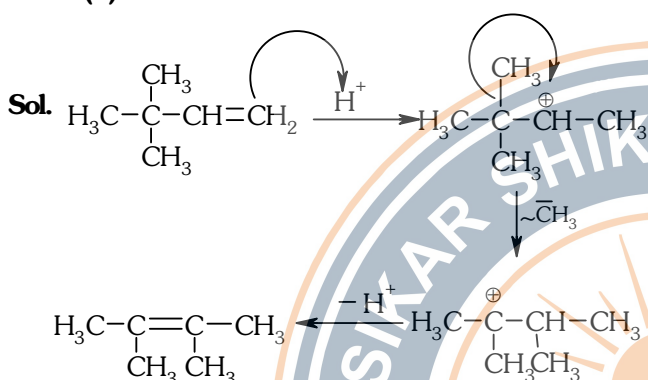

2. Gadolinium belongs to 4f series. Its atomic number is 64. Which of the following is the correct electronic configuration of gadolinium ?

- (1) $[\text{Xe}] 4f^7 5d^1 6s^2$ (2) $[\text{Xe}] 4f^6 5d^2 6s^2$
 (3) $[\text{Xe}] 4f^8 6d^2$ (4) $[\text{Xe}] 4f^9 5s^1$

Ans. (1)

Sol. ${}_{64}\text{Gd} = {}_{54}\text{Xe} 6s^2 4f^7 5d^1$

3. The formation of the oxide ion, $\text{O}^{2-}(\text{g})$, from oxygen atom requires first an exothermic and then an endothermic step as shown below :

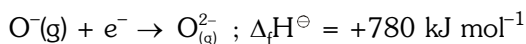
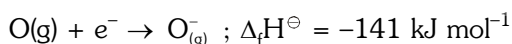

Thus process of formation of O^{2-} in gas phase is unfavourable even though O^{2-} is isoelectronic with neon. It is due to the fact that,

- (1) Oxygen is more electronegative
 (2) Addition of electron in oxygen results in larger size of the ion
 (3) Electron repulsion outweighs the stability gained by achieving noble gas configuration
 (4) O^- ion has comparatively smaller size than oxygen atom

Ans. (3)

4. The number of structural isomers possible from the molecular formula $\text{C}_3\text{H}_9\text{N}$ is :

- (1) 2 (2) 3 (3) 4 (4) 5

Ans. (3)

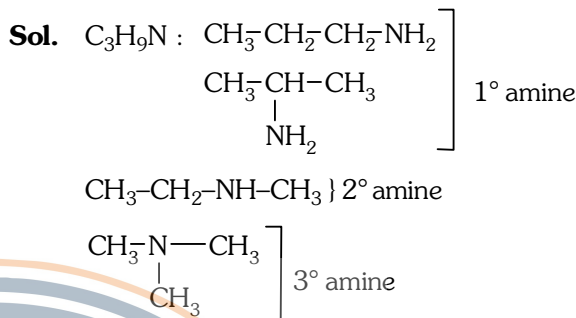

5. If the equilibrium constant for $\text{N}_2(\text{g}) + \text{O}_2(\text{g}) \rightleftharpoons 2\text{NO}(\text{g})$ is K, the equilibrium

constant for $\frac{1}{2}\text{N}_2(\text{g}) + \frac{1}{2}\text{O}_2(\text{g}) \rightleftharpoons \text{NO}(\text{g})$ will

be :-

- (1) K (2) K^2 (3) $K^{1/2}$ (4) $\frac{1}{2}K$

Ans. (3)

Sol. $\text{N}_2(\text{g}) + \text{O}_2(\text{g}) \rightleftharpoons 2\text{NO}(\text{g}) ; K$

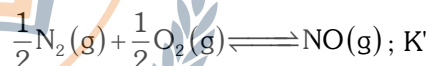

when a reaction is multiplied by 1/2 then $K' = (K)^{1/2}$

6. Which one of the following pairs of solution is not an acidic buffer ?

- (1) H_2CO_3 and Na_2CO_3
 (2) H_3PO_4 and Na_3PO_4
 (3) HClO_4 and NaClO_4
 (4) CH_3COOH and CH_3COONa

Ans. (3)

Sol. HClO_4 and NaClO_4 cannot act as an acidic buffer.

7. Aqueous solution of which of the following compounds is the best conductor of electric current?

- (1) Ammonia, NH_3
 (2) Fructose, $\text{C}_6\text{H}_{12}\text{O}_6$
 (3) Acetic acid, $\text{C}_2\text{H}_4\text{O}_2$
 (4) Hydrochloric acid, HCl

Ans. (4)

Sol. Aqueous solution of HCl is the best conductor of electric current because HCl is strong acid, so it dissociates completely into ions.

8. Caprolactam is used for the manufacture of :

- (1) Terylene (2) Nylon - 6, 6
(3) Nylon - 6 (4) Teflon

Ans. (3)

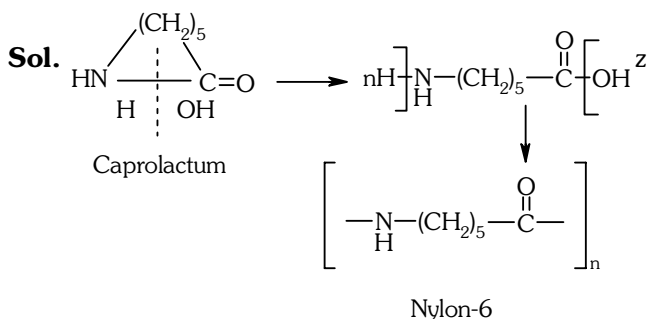

9. On heating which of the following releases CO_2 most easily ?

- (1) MgCO_3 (2) CaCO_3
(3) K_2CO_3 (4) Na_2CO_3

Ans. (1)

Sol. Thermal stability order



Therefore MgCO_3 releases CO_2 most easily

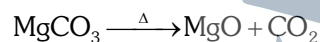

10. Strong reducing behaviour of H_3PO_2 is due to :

- (1) High oxidation state of phosphorus
(2) Presence of two $-\text{OH}$ groups and one $\text{P}-\text{H}$ bond
(3) Presence of one $-\text{OH}$ group and two $\text{P}-\text{H}$ bonds
(4) High electron gain enthalpy of phosphorus

Ans. (3)

Sol. Strong reducing behaviour of H_3PO_2

All oxy-acid of phosphorus which contain $\text{P}-\text{H}$ bond act as reductant.

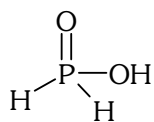

presence of one $-\text{OH}$ group and two $\text{P}-\text{H}$ bonds

11. Decreasing order of stability of O_2 , O_2^- , O_2^+ and O_2^{2-} is :-

- (1) $\text{O}_2 > \text{O}_2^+ > \text{O}_2^{2-} > \text{O}_2^-$
(2) $\text{O}_2^- > \text{O}_2^{2-} > \text{O}_2^+ > \text{O}_2$
(3) $\text{O}_2^+ > \text{O}_2 > \text{O}_2^- > \text{O}_2^{2-}$
(4) $\text{O}_2^{2-} > \text{O}_2^- > \text{O}_2 > \text{O}_2^+$

Ans. (3)

Sol. Given species : O_2 , O_2^{-1} , O_2^{+1} , O_2^{2-}
Total number of electrons

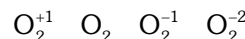
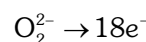
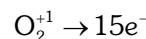
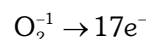
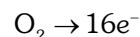

Bond order 2.5 2 1.5 1

Stability \times B.O.

* Stability order $[\text{O}_2^{+1} > \text{O}_2 > \text{O}_2^{-1} > \text{O}_2^{2-}]$

12. The number of water molecules is maximum in :-

- (1) 18 gram of water
(2) 18 moles of water
(3) 18 molecules of water
(4) 1.8 gram of water

Ans. (2)

Sol. \therefore 1 mole water = 6.02×10^{23} molecules
 \therefore 18 mole water = $18 \times 6.02 \times 10^{23}$ molecules
so, 18 mole water has maximum number of molecules.

13. In which of the following pairs, both the species are not isostructural ?

- (1) NH_3 , PH_3
(2) XeF_4 , XeO_4
(3) SiCl_4 , PCl_4^+
(4) Dimond, silicon carbide

Ans. (2)

Sol. (i) Hybridisation of NH_3 [$\sigma=3$, $\text{lp}=1$]
 sp^3 geometry : tetrahedral

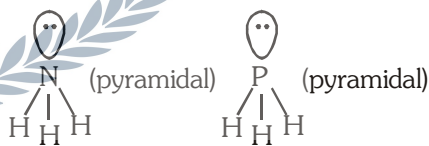

(ii) Structures of XeF_4 is square planar.

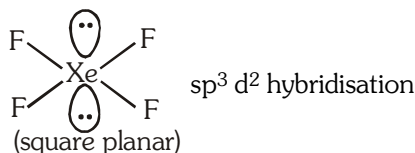

Structure of XeO_4 is tetrahedral

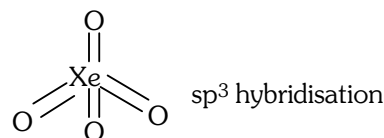

so XeF_4 and XeO_4 are not isostructural

(iii) Structure of SiCl_4 is tetrahedral

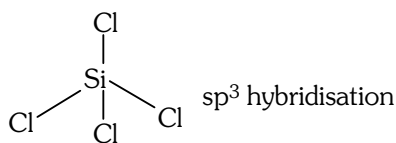

Structure of PCl_4^+ is tetrahedral

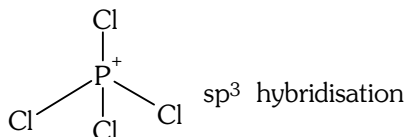

(iv) Diamond & SiC both are isostructural because both have tetrahedral arrangement and central atom is sp^3 hybridised.

- 14.** In the reaction with HCl, an alkene reacts in accordance with the Markovnikov's rule, to give a product 1-chloro-1-methylcyclohexane. The possible alkene is :-

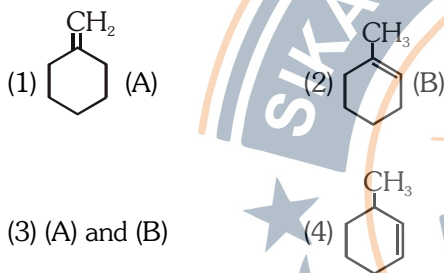

Ans. (3)

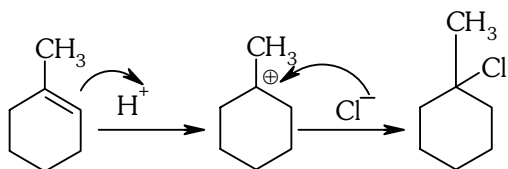
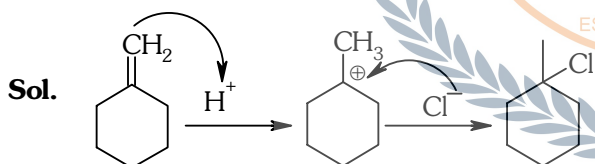

- 15.** Assuming complete ionization, same moles of which of the following compounds will require the least amount of acidified KMnO_4 for complete oxidation?



Ans. (3)

- 16.** Reaction of phenol with chloroform in presence of dilute sodium hydroxide finally introduces which one of the following functional group ?



Ans. (2)

Reimer Tieman reaction

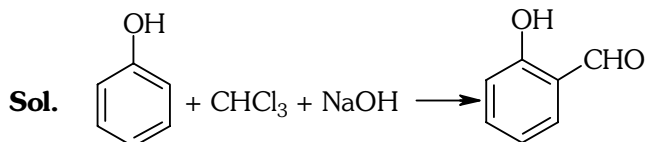

- 17.** The vacant space in bcc lattice unit cell is :



Ans. (2)

Sol. Packing efficiency in bcc lattice = 68%
 \therefore vacant space in bcc lattice = $100 - 68 = 32\%$

- 18.** Which of the statements given below is incorrect ?

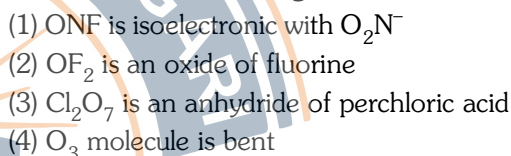

Ans. (2)

Sol. (i) No. of electron in ONF = 24
 No. of electron in NO_2^- = 24
 both are isoelectronic
 (ii) OF_2 is a fluoride of oxygen not oxide of fluorine
 OF_2 = oxygen difluoride
 (iii) Cl_2O_7 is an anhydride of perchloric acid

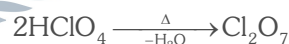

(iv) O_3 molecule is bent bent shape

- 19.** The name of complex ion, $[\text{Fe}(\text{CN})_6]^{3-}$ is :-

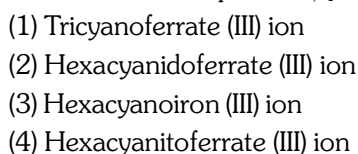

Ans. (2)

Sol. $[\text{Fe}(\text{CN})_6]^{3-}$

Hexacyanido ferrate (III) ion

20. If avogadro number N_A , is changed from $6.022 \times 10^{23} \text{ mol}^{-1}$ to $6.022 \times 10^{20} \text{ mol}^{-1}$, this would change :

- (1) the ratio of chemical species to each other in a balanced equation
- (2) the ratio of elements to each other in a compound
- (3) the definition of mass in units of grams
- (4) the mass of one mole of carbon

Ans. (4)

Sol. \therefore mass of 1 mol (6.022×10^{23} atoms) of carbon = 12g

If Avogadro Number (N_A) is changed than mass of 1 mol (6.022×10^{20} atom) of carbon

$$= \frac{12 \times 6.022 \times 10^{20}}{6.022 \times 10^{23}} = 12 \times 10^{-3} \text{ g}$$

Therefore the mass of 1 mol of carbon is changed

21. Which of the following statements is not correct for a nucleophile ?

- (1) Nucleophiles attack low e^- density sites
- (2) Nucleophiles are not electron seeking
- (3) Nucleophile is a Lewis acid
- (4) Ammonia is a nucleophile

Ans. (3)

Sol. Reason : Nucleophiles are electron rich species so act as Lewis base.

22. A gas such as carbon monoxide would be most likely to obey the ideal gas law at :

- (1) high temperatures and high pressures
- (2) low temperatures and low pressures
- (3) high temperatures and low pressures
- (4) low temperatures and high pressures

Ans. (3)

Sol. Real gases show ideal gas behaviour at high temperatures and low pressures.

23. The hybridization involved in complex $[\text{Ni}(\text{CN})_4]^{2-}$ is (At.No. Ni = 28)

- (1) d^2sp^2
- (2) d^2sp^3
- (3) dsp^2
- (4) sp^3

Ans. (3)

Sol. $[\text{Ni}(\text{CN})_4]^{2-}$
oxidation state of Ni is +2
 $x - 4 = 2$
 $x = +2$



due to presence of strong field ligand all unpaired electrons are paired up.

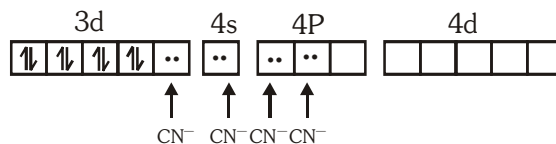

Hybridisation of $[\text{Ni}(\text{CN})_4]^{2-}$ is dsp^2

24. The heat of combustion of carbon to CO_2 is -393.5 kJ/mol . The heat released upon formation of 35.2 g of CO_2 from carbon and oxygen gas is:

- (1) -630 kJ
- (2) -3.15 kJ
- (3) -315 kJ
- (4) $+315 \text{ kJ}$

Ans. (3)

Sol. Formation of CO_2 from carbon and dioxygen gas can be represented as



(1 mole = 44 g)

Heat released on formation of 44 g CO_2 = $-393.5 \text{ kJ mol}^{-1}$

$$= \frac{-393.5 \text{ kJ mol}^{-1}}{44 \text{ g}} \times 35.2 \text{ g}$$

$$= -315 \text{ kJ}$$

25. 20.0 g of a magnesium carbonate sample decomposes on heating to give carbon dioxide and 8.0g magnesium oxide. What will be the percentage purity of magnesium carbonate in the sample ?

- (1) 60
- (2) 84
- (3) 75
- (4) 96

(At. Wt. : Mg = 24)

Ans. (2)

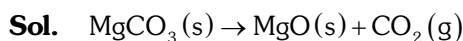

$$\text{moles of MgCO}_3 = \frac{20}{84} = 0.238 \text{ mol}$$

From above equation

1 mole MgCO_3 gives 1 mole MgO

\therefore 0.238 mole MgCO_3 will give 0.238 mole MgO
= $0.238 \times 40 \text{ g} = 9.523 \text{ g MgO}$

Practical yield of $\text{MgO} = 8 \text{ g MgO}$

$$\therefore \% \text{ purity} = \frac{8}{9.523} \times 100 = 84\%$$

26. What is the mole fraction of the solute in a 1.00 m aqueous solution ?

- (1) 0.0354 (2) 0.0177
(3) 0.177 (4) 1.770

Ans. (2)

Sol. 1.00 m solution means 1 mole solute is present in 1000 g water.

$$n_{\text{H}_2\text{O}} = \frac{1000}{18} = 55.5 \text{ mol H}_2\text{O}$$

$$X_{\text{solute}} = \frac{n_{\text{solute}}}{n_{\text{solute}} + n_{\text{H}_2\text{O}}} = \frac{1}{1 + 55.5} = 0.0177$$

27. The correct statement regarding defects in crystalline solids is :-

- (1) Frenkel defect is a dislocation defect
(2) Frenkel defect is found in halides of alkaline metals
(3) Schottky defects have no effect on the density of crystalline solids
(4) Frenkel defects decrease the density of crystalline solids

Ans. (1)

Sol. Frenkel defect is a dislocation defect

28. The stability of +1 oxidation state among Al, Ga, In and Tl increases in the sequence :

- (1) Tl < In < Ga < Al
(2) In < Tl < Ga < Al
(3) Ga < In < Al < Tl
(4) Al < Ga < In < Tl

Ans. (4)

Sol. Stability of +1 oxidation state due to inert pair effect Tl > In > Ga > Al

29. Two possible stereo-structures of $\text{CH}_3\text{CHOH.COOH}$, which are optically active, are called :-

- (1) Enantiomers
(2) Mesomers
(3) Diastereomers
(4) Atropisomers

Ans. (1)

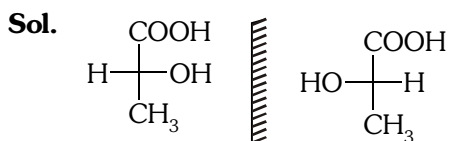

Both are enantiomers

30. The following reaction

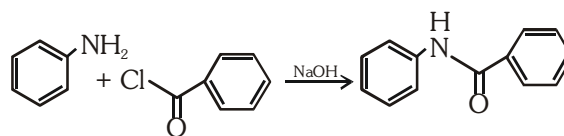

is known by the name :

- (1) Acetylation reaction
(2) Schotten-Bauman reaction
(3) Friedel-Craft's reaction
(4) Perkin's reaction

Ans. (2)

Sol. Benzoylation of aniline is an example of Schotten Bauman reaction.

31. The sum of coordination number and oxidation number of the metal M in the complex $[\text{M}(\text{en})_2(\text{C}_2\text{O}_4)]\text{Cl}$ (where en is ethylenediamine) is :-

- (1) 7 (2) 8 (3) 9 (4) 6

Ans. (3)

Sol. $[\text{M}(\text{en})_2(\text{C}_2\text{O}_4)]\text{Cl}$

oxidation state of M = + 3

Coordination number of M = 6

Sum of oxidation state + coordination number

$$= 3 + 6 = 9$$

32. Reaction of carbonyl compound with one of the following reagents involves nucleophilic addition followed by elimination of water. The reagent is :

- (1) hydrocyanic acid
(2) sodium hydrogen sulphite
(3) a Grignard reagent
(4) hydrazine in presence of feebly acidic solution

Ans. (4)

Sol. Reaction of carbonyl compounds with ammonia derivatives is an example of Nucleophilic addition elimination reaction.

33. Which one of the following esters gets hydrolysed *most easily* under alkaline conditions ?

- (1)
- (2)
- (3)
- (4)

Ans. (3)

Sol. EWG (electron withdrawing group) increases reactivity towards nucleophilic substitution reaction. $-\text{NO}_2$ is strong electron withdrawing group.

34. In an $\text{S}_{\text{N}}1$ reaction on chiral centres, there is :

- (1) 100% retention
- (2) 100% inversion
- (3) 100% racemization
- (4) inversion more than retention leading to partial racemization

Ans. (4)

Sol. $\text{S}_{\text{N}}1$ reaction gives racemic mixture with slight predominance of that isomer which corresponds to inversion because $\text{S}_{\text{N}}1$ also depends upon the degree of 'shielding' of the front side of the reacting carbon.

35. The rate constant of the reaction $\text{A} \rightarrow \text{B}$ is 0.6×10^{-3} mole per second. If the concentration of A is 5 M, then concentration of B after 20 minutes is :-

- (1) 0.36 M
- (2) 0.72 M
- (3) 1.08 M
- (4) 3.60 M

Ans. (2)

Sol. For zero order reaction :

$$x = K.t$$
$$= 0.6 \times 10^{-3} \times 20 \times 60$$
$$x = 0.72 \text{ M}$$

36. What is the pH of the resulting solution when equal volumes of 0.1 M NaOH and 0.01 M HCl are mixed ?

- (1) 7.0
- (2) 1.04
- (3) 12.65
- (4) 2.0

Ans. (3)

Sol. $N_1V_1 - N_2V_2 = N.V.$

$$0.1 \times 1 - 0.01 \times 1 = N \times 2$$

$$[\text{OH}^-] = N_{\text{R}} = \frac{0.09}{2} = 0.045 \text{ N}$$

$$\text{pOH} = -\log(0.045) = 1.35$$

$$\therefore \text{pH} = 14 - \text{pOH} = 14 - 1.35 = 12.65$$

37. Number of possible isomers for the complex $[\text{Co}(\text{en})_2\text{Cl}_2]\text{Cl}$ will be : (en = ethylenediamine)

- (1) 3
- (2) 4
- (3) 2
- (4) 1

Ans. (1)

Sol. $[\text{Co}(\text{en})_2\text{Cl}_2]\text{Cl}$

Possible isomers -

(i) Geometrical isomers

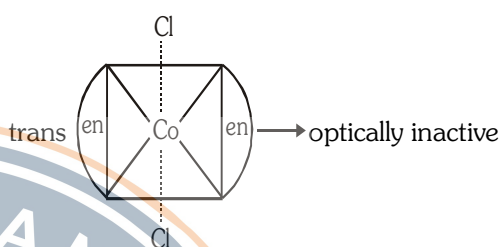
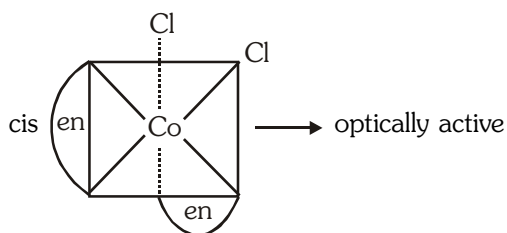

(ii) In trans form plane of symmetry present, so trans form is optically inactive but cis is optically active.

Total number of stereoisomer = $2+1=3$

38. The variation of the boiling points of the hydrogen halides is in the order $\text{HF} > \text{HI} > \text{HBr} > \text{HCl}$. What explains the higher boiling point of hydrogen fluoride ?

- (1) The bond energy of HF molecules is greater than in other hydrogen halides
- (2) The effect of nuclear shielding is much reduced in fluorine which polarises the HF molecule
- (3) The electronegativity of fluorine is much higher than for other elements in the group.
- (4) There is strong hydrogen bonding between HF molecules

Ans. (4)

Sol. Due to strong H-bonding in HF molecule, boiling point is highest for HF

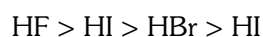

39. What is the mass of the precipitate formed when 50 mL of 16.9% solution of AgNO_3 is mixed with 50 mL of 5.8% NaCl solution ?

(Ag = 107.8, N = 14, O = 16, Na = 23, Cl = 35.5)

- (1) 7 g
- (2) 14 g
- (3) 28 g
- (4) 3.5 g

Ans. (1)

Sol. 16.9 g AgNO_3 is present in 100 mL solution.
 \therefore 8.45 g AgNO_3 is present in 50 mL solution
5.8 g NaCl is present in 100 mL solution
 \therefore 2.9 g NaCl is present in 50 mL solution

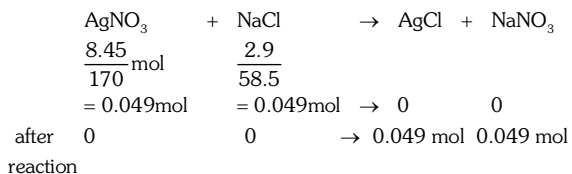

mass of AgCl precipitated
= $0.049 \times 143.5 \text{ g}$
= 7 g AgCl

40. The oxidation of benzene by V_2O_5 in the presence of air produces :

- (1) benzoic acid (2) benzaldehyde
(3) benzoic anhydride (4) maleic anhydride

Ans. (4)

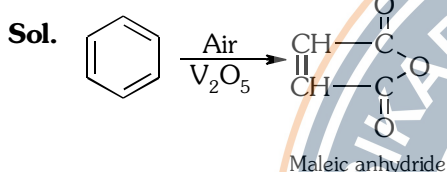

41. Which of the following is not the product of

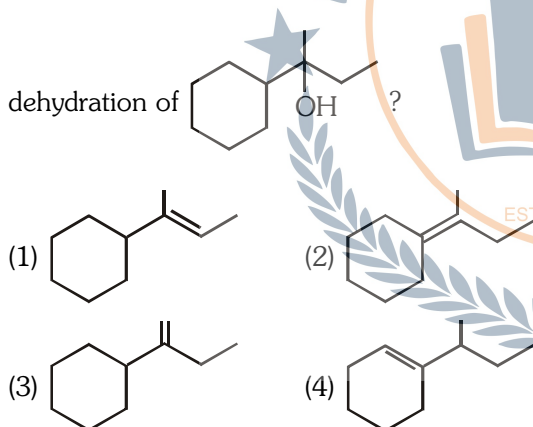

Ans. (4)

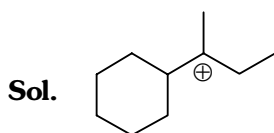

Intermediate carbocation (more stable).
No rearrangement in C^+ takes place.

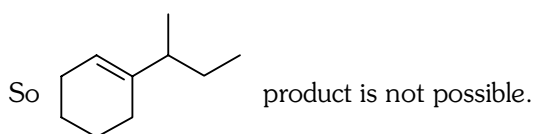

42. Method by which Aniline cannot be prepared is :-

- (1) reduction of nitrobenzene with H_2/Pd in ethanol
(2) potassium salt of phthalimide treated with chlorobenzene followed by hydrolysis with aqueous NaOH solution
(3) hydrolysis of phenylisocyanide with acidic solution
(4) degradation of benzamide with bromine in alkaline solution

Ans. (2)

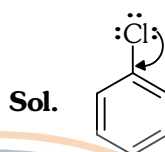

due to resonance $\text{C}-\text{Cl}$ bond acquires double bond character.

43. Which of the following reaction(s) can be used for the preparation of alkyl halides ?

- (I) $\text{CH}_3\text{CH}_2\text{OH} + \text{HCl} \xrightarrow{\text{anh. ZnCl}_2}$
(II) $\text{CH}_3\text{CH}_2\text{OH} + \text{HCl} \longrightarrow$
(III) $(\text{CH}_3)_3\text{COH} + \text{HCl} \longrightarrow$
(IV) $(\text{CH}_3)_2\text{CHOH} + \text{HCl} \xrightarrow{\text{anh. ZnCl}_2}$

- (1) (IV) only (2) (III) and (IV) only
(3) (I), (III) and (IV) only (4) (I) and (II) only

Ans. (3)

Sol. (I) and (IV) can be used due to presence of anhydrous ZnCl_2 (III) gives alkyl halide due to formation of more stable carbocation.

44. Which is the correct order of increasing energy of the listed orbitals in the atom of titanium ?

(At. no. $Z = 22$)

- (1) 3s 3p 3d 4s (2) 3s 3p 4s 3d
(3) 3s 4s 3p 3d (4) 4s 3s 3p 3d

Ans. (2)

Sol. $\text{Ti}(22) = 1s^2 2s^2 2p^6 3s^2 3p^6 4s^2 3d^2$
order of energy is 3s 3p 4s 3d

45. In the extraction of copper from its sulphide ore, the metal is finally obtained by the reduction of cuprous oxide with :-

- (1) copper(I) sulphide
(2) sulphur dioxide
(3) iron(II) sulphide
(4) carbon monoxide

Ans. (1)

Sol. Self reduction
 $\text{Cu}_2\text{S} + 2\text{Cu}_2\text{O} \rightarrow 6\text{Cu} + \text{SO}_2 \uparrow$

- 46.** Root pressure develops due to :
- (1) Increase in transpiration
 - (2) Active absorption
 - (3) Low osmotic potential in soil
 - (4) Passive absorption

Ans. (2)

- 47.** Which one is a **wrong** statement ?
- (1) Brown algae have chlorophyll a and c, and fucoxanthin
 - (2) Archegonia are found in Bryophyta, Pteridophyta and Gymnosperms
 - (3) *Mucor* has biflagellate zoospores
 - (4) Haploid endosperm is typical feature of gymnosperms

Ans. (3)

- 48.** Which of the following structures is **not** found in prokaryotic cells?
- (1) Plasma membrane
 - (2) Nuclear envelope
 - (3) Ribosome
 - (4) Mesosome

Ans. (2)

- 49.** Which one of the following animals has two separate circulatory pathways ?
- (1) Shark
 - (2) Frog
 - (3) Lizard
 - (4) Whale

Ans. (4)

- 50.** Most animals that live in deep oceanic waters are:
- (1) Detritivores
 - (2) Primary consumers
 - (3) Secondary consumers
 - (4) Tertiary consumers

Ans. (1)

- 51.** An association of individuals of different species living in the same habitat and having functional interactions is :
- (1) Population
 - (2) Ecological niche
 - (3) Biotic community
 - (4) Ecosystem

Ans. (3)

- 52.** The oxygen evolved during photosynthesis comes from water molecules. Which one of the following pairs of elements is involved in this reaction?
- (1) Magnesium and Chlorine
 - (2) Manganese and Chlorine
 - (3) Manganese and Potassium
 - (4) Magnesium and Molybdenum

Ans. (2)

- 53.** Axile placentation is present in :

- (1) *Argemone*
- (2) *Dianthus*
- (3) Lemon
- (4) Pea

Ans. (3)

- 54.** In which of the following both pairs have **correct** combination :

(1)	Gaseous nutrient cycle	Sulphur and Phosphorus
	Sedimentary nutrient cycle	Carbon and Nitrogen
(2)	Gaseous nutrient cycle	Carbon and Nitrogen
	Sedimentary nutrient cycle	Sulphur and Phosphorus
(3)	Gaseous nutrient cycle	Carbon and sulphur
	Sedimentary nutrient cycle	Nitrogen and phosphorus
(4)	Gaseous nutrient cycle	Nitrogen and sulphur
	Sedimentary nutrient cycle	Carbon and Phosphorus

Ans. (2)

- 55.** In mammalian eye, the 'fovea' is the center of the visual field, where :

- (1) more rods than cones are found.
- (2) high density of cones occur, but has no rods
- (3) the optic nerve leaves the eye
- (4) only rods are present

Ans. (2)

- 56.** Choose the **wrong** statement :

- (1) Yeast is unicellular and useful in fermentation
- (2) *Penicillium* is multicellular and produces antibiotics
- (3) *Neurospora* is used in the study of biochemical genetics
- (4) Morels and truffles are poisonous mushrooms

Ans. (4)

- 57.** Which of the following are **not** membrane-bound?

- (1) Mesosomes
- (2) Vacuoles
- (3) Ribosomes
- (4) Lysosomes

Ans. (3)

- 58.** In which of the following interactions both partners are adversely affected ?

- (1) Mutualism
- (2) Competition
- (3) Predation
- (4) Parasitism

Ans. (2)

59. A colour blind man marries a woman with normal sight who has no history of colour blindness in her family. What is the probability of their grandson being colour blind ?

- (1) 0.25 (2) 0.5
(3) 1 (4) Nil

Ans. (4)

60. Ectopic pregnancies are referred to as :

- (1) Pregnancies terminated due to hormonal imbalance
(2) Pregnancies with genetic abnormality.
(3) Implantation of embryo at site other than uterus.
(4) Implantation of defective embryo in the uterus

Ans. (3)

61. Cellular organelles with membranes are :

- (1) Lysosomes, Golgi apparatus and mitochondria
(2) Nuclei, ribosomes and mitochondria
(3) Chromosomes, ribosomes and endoplasmic reticulum
(4) Endoplasmic reticulum, ribosomes and nuclei

Ans. (1)

62. Cell wall is absent in :

- (1) *Nostoc* (2) *Aspergillus*
(3) *Funaria* (4) Mycoplasma

Ans. (4)

63. The term "linkage" was coined by :

- (1) W.Sutton (2) T.H. Morgan
(3) T.Boveri (4) G.Mendel

Ans. (2)

64. Which of the following biomolecules does have a phosphodiester bond ?

- (1) Nucleic acids in a nucleotide
(2) Fatty acids in a diglyceride
(3) Monosaccharides in a polysaccharide
(4) Amino acids in a polypeptide

Ans. (1)

65. The primary dentition in human differs from permanent dentition in **not** having one of the following type of teeth :

- (1) Incisors
(2) Canine
(3) Premolars
(4) Molars

Ans. (3)

66. A protoplast is a cell :

- (1) without cell wall
(2) without plasma membrane
(3) without nucleus
(4) undergoing division

Ans. (1)

67. In which group of organisms the cells walls form two thin overlapping shells which fit together ?

- (1) Slime moulds (2) Chrysophytes
(3) Euglenoids (4) Dinoflagellates

Ans. (2)

68. The DNA molecules to which the gene of interest is integrated for cloning is called :

- (1) Carrier (2) Transformer
(3) Vector (4) Template

Ans. (3)

69. Male gametophyte in angiosperms produces :

- (1) Three sperms
(2) Two sperms and a vegetative cell
(3) Single sperm and a vegetative cell
(4) Single sperm and two vegetative cells

Ans. (2)

70. Coconut water from a tender coconut is :

- (1) Degenerated nucellus
(2) Immature embryo
(3) Free nuclear endosperm
(4) Innermost layers of the seed coat

Ans. (3)

71. The species confined to a particular region and not found elsewhere is termed as :

- (1) Rare (2) Keystone (3) Alien (4) Endemic

Ans. (4)

72. Metagenesis refers to :

- (1) Presence of a segmented body and parthenogenetic mode of reproduction
(2) Presence of different morphic forms
(3) Alternation of generation between asexual and sexual phases of an organism
(4) Occurrence of a drastic change in form during post-embryonic development

Ans. (3)

73. The enzymes that is **not** present in succus entericus is :

- (1) lipase (2) maltase
(3) nucleases (4) nucleosidase

Ans. (3)

- 74.** Eutrophication of water bodies leading to killing of fishes is mainly due to non-availability of :
- (1) oxygen (2) food
(3) light (4) essential minerals

Ans. (1)

- 75.** The function of the gap junction is to :
- (1) stop substance from leaking across a tissue
(2) performing cementing to keep neighbouring cells together
(3) Facilitate communication between adjoining cells by connecting the cytoplasm for rapid transfer of ions, small molecules and some large molecules
(4) separate two cells from each other.

Ans. (3)

- 76.** Match the following list of microbes and their importance :

(a)	<i>Saccharomyces cerevisiae</i>	(i)	Production of immunosuppressive agents
(b)	<i>Monascus purpureus</i>	(ii)	Ripening of Swiss cheese
(c)	<i>Trichoderma polysporum</i>	(iii)	Commercial production of ethanol
(d)	<i>Propionibacterium sharmanii</i>	(iv)	Production of blood cholesterol lowering agents

- | | | | |
|------------|------------|------------|------------|
| (a) | (b) | (c) | (d) |
| (1) (iii) | (i) | (iv) | (ii) |
| (2) (iii) | (iv) | (i) | (ii) |
| (3) (iv) | (iii) | (ii) | (i) |
| (4) (iv) | (ii) | (i) | (iii) |

Ans. (2)

- 77.** Arrange the following events of meiosis in correct sequence :

- (a) Crossing over
(b) Synapsis
(c) Terminalisation of chiasmata
(d) Disappearance of nucleolus
- (1) (b), (c), (d), (a) (2) (b), (a), (d), (c)
(3) (b), (a), (c), (d) (4) (a), (b), (c), (d)

Ans. (3)

- 78.** The cutting of DNA at specific locations became possible with the discovery of :
- (1) Ligases (2) Restriction enzymes
(3) Probes (4) Selectable markers

Ans. (2)

- 79.** During biological nitrogen fixation, inactivation of nitrogenase by oxygen poisoning prevented by :
- (1) Cytochrome (2) Leghaemoglobin
(3) Xanthophyll (4) Carotene

Ans. (2)

- 80.** Grafted kidney may be rejected in a patient due to
- (1) Innate immune response
(2) Humoral immune response
(3) Cell-mediated immune response
(4) Passive immune response

Ans. (3)

- 81.** The body cells in cockroach discharge their nitrogenous waste in the haemolymph mainly in the form of :

- (1) Calcium carbonate (2) Ammonia
(3) Potassium urate (4) Urea

Ans. (3)

- 82.** Filiform apparatus is characteristic feature of :

- (1) Synergids
(2) Generative cell
(3) Nucellar embryo
(4) Aleurone cell

Ans. (1)

- 83.** Acid rain is caused by increase in the atmospheric concentration of :

- (1) O₃ and dust (2) SO₂ and NO₂
(3) SO₃ and CO (4) CO₂ and CO

Ans. (2)

- 84.** The wheat grain has an embryo with one large, shield-shaped cotyledon known as :

- (1) Coleoptile (2) Epiblast
(3) Coleorrhiza (4) Scutellum

Ans. (4)

- 85.** Among china rose, mustard, brinjal, potato, guava, cucumber, onion and tulip, how many plants have superior ovary?

- (1) Four (2) Five (3) Six (4) Three

Ans. (3)

- 86.** Which of the following is **not** a function of the skeletal system?

- (1) Locomotion
(2) Production of erythrocytes
(3) Storage of minerals
(4) Production of body heat

Ans. (4)

87. Golden rice is a genetically modified crop plant where the incorporated gene is meant for biosynthesis of :

- (1) Vitamin A
- (2) Vitamin B
- (3) Vitamin C
- (4) Omega 3

Ans. (1)

88. Chromatophores take part in :

- (1) Respiration
- (2) Photosynthesis
- (3) Growth
- (4) Movement

Ans. (2)

89. Select the **wrong** statement :

- (1) Mosaic disease in tobacco and AIDS in human being are caused by viruses
- (2) The viroids were discovered by D.J. Ivanowski
- (3) W.M. Stanley showed that viruses could be crystallized
- (4) The term 'contagium vivum fluidum' was coined by M.W. Beijerinck

Ans. (2)

90. A pleiotropic gene :

- (1) controls multiple traits in an individual
- (2) is expressed only in primitive plants
- (3) is a gene evolved during Pliocene
- (4) controls a trait only in combination with another gene

Ans. (1)

91. Human urine is usually acidic because :

- (1) hydrogen ions are actively secreted into the filtrate.
- (2) the sodium transporter exchanges one hydrogen ion for each sodium ion, in peritubular capillaries.
- (3) excreted plasma proteins are acidic
- (4) potassium and sodium exchange generates acidity

Ans. (1)

92. Auxin can be bioassayed by :

- (1) Lettuce hypocotyl elongation
- (2) Avena coleoptile curvature
- (3) Hydroponics
- (4) Potometer

Ans. (2)

93. Which of the following events is **not** associated with ovulation in human female?

- (1) LH surge
- (2) Decrease in estradiol
- (3) Full development of Graafian follicle
- (4) Release of secondary oocyte

Ans. (2)

94. Body having meshwork of cells, internal cavities lined with food filtering flagellated cells and indirect development are the characteristics of phylum :

- (1) Protozoa
- (2) Coelenterata
- (3) Porifera
- (4) Mollusca

Ans. (3)

95. Which one of the following hormones is **not** involved in sugar metabolism ?

- (1) Glucagon
- (2) Cortisone
- (3) Aldosterone
- (4) Insulin

Ans. (3)

96. Which of the following diseases is caused by a protozoan ?

- (1) Blastomycosis
- (2) Syphilis
- (3) Influenza
- (4) Babesiosis

Ans. (4)

97. Outbreeding is an important strategy of animal husbandry because it :

- (1) exposes harmful recessive genes that are eliminated by selection
- (2) helps in accumulation of superior genes.
- (3) is useful in producing purelines of animals.
- (4) is useful in overcoming inbreeding depression

Ans. (4)

98. A childless couple can be assisted to have a child through a technique called GIFT. The full form of this technique is :

- (1) Germ cell internal fallopian transfer
- (2) Gamete inseminated fallopian transfer
- (3) Gamete intra fallopian transfer
- (4) Gamete internal fertilization and transfer

Ans. (3)

99. A jawless fish, which lays eggs in fresh water and whose ammocoetes larvae after metamorphosis return to the ocean is :

- (1) *Petromyzon*
- (2) *Eptatretus*
- (3) *Myxine*
- (4) *Neomyxine*

Ans. (1)

100. The structures that help some bacteria to attach to rocks and/or host tissues are :

- (1) Holdfast
- (2) Rhizoids
- (3) Fimbriae
- (4) Mesosomes

Ans. (3)

101. If you suspect major deficiency of antibodies in a person, to which of the following would you look for confirmatory evidence?

- (1) Serum globulins
- (2) Fibrinogen in plasma
- (3) Serum albumins
- (4) Haemocytes

Ans. (1)

102. In human females, meiosis-II is not completed until?

- (1) birth
- (2) puberty
- (3) fertilization
- (4) uterine implantation

Ans. (3)

103. Which of the following layers in an antral follicle is acellular ?

- (1) Zona pellucida
- (2) Granulosa
- (3) Theca interna
- (4) Stroma

Ans. (1)

104. In his classic experiments on pea plants, Mendel did not use :

- (1) Flower position
- (2) Seed colour
- (3) Pod length
- (4) Seed shape

Ans. (3)

105. Which one of the following fruits is parthenocarpic?

- (1) Banana
- (2) Brinjal
- (3) Apple
- (4) Jackfruit

Ans. (1)

106. In angiosperms, microsporogenesis and megasporogenesis :

- (1) occur in ovule
- (2) occur in anther
- (3) form gametes without further divisions
- (4) involve meiosis

Ans. (4)

107. A gene showing codominance has :

- (1) both alleles independently expressed in the heterozygote
- (2) one allele dominant on the other
- (3) alleles tightly linked on the same chromosome
- (4) alleles that are recessive to each other

Ans. (1)

108. The chitinous exoskeleton of arthropods is formed by the polymerisation of :

- (1) lipoglycans
- (2) keratin sulphate and chondroitin sulphate
- (3) D-glucosamine
- (4) N-acetyl glucosamine

Ans. (4)

109. The imperfect fungi which are decomposers of litter and help in mineral cycling belong to :

- (1) Ascomycetes
- (2) Deuteromycetes
- (3) Basidiomycetes
- (4) Phycomycetes

Ans. (2)

110. The wings of a bird and the wings of an insect are :

- (1) homologous structures and represent convergent evolution
- (2) homologous structures and represent divergent evolution
- (3) analogous structures and represent convergent evolution
- (4) phylogenetic structures and represent divergent evolution

Ans. (3)

111. Flowers are unisexual in :

- (1) Onion
- (2) Pea
- (3) Cucumber
- (4) China rose

Ans. (3)

112. Increase in concentration of the toxicant at successive trophic levels is known as :

- (1) Biogeochemical cycling
- (2) Biomagnification
- (3) Biodeterioration
- (4) Biotransformation

Ans. (2)

113. Destruction of the anterior horn cells of the spinal cord would result in loss of :-

- (1) Integrating impulses
- (2) Sensory impulses
- (3) voluntary motor impulses
- (4) Commissural impulses

Ans. (3)

114. Roots play insignificant role in absorption of water in :

- (1) Wheat (2) Sunflower (3) *Pistia* (4) Pea

Ans. (3)

115. Match the columns and identify the correct option:

	Column-I		Column-II
(a)	Thylakoids	(i)	Disc-shaped sacs in Golgi apparatus
(b)	Cristae	(ii)	Condensed structure of DNA
(c)	Cisternae	(iii)	Flat membranous sacs in stroma
(d)	Chromatin	(iv)	Infoldings in mitochondria

- | | | | |
|------------|------------|------------|------------|
| (a) | (b) | (c) | (d) |
| (1) (iii) | (iv) | (ii) | (i) |
| (2) (iv) | (iii) | (i) | (ii) |
| (3) (iii) | (iv) | (i) | (ii) |
| (4) (iii) | (i) | (iv) | (ii) |

Ans. (3)

116. Identify the **correct** order of organisation of genetic material from largest to smallest :

- (1) Chromosome, genome, nucleotide, gene
 (2) Chromosome, gene, genome, nucleotide
 (3) Genome, chromosomes, nucleotide, gene
 (4) Genome, chromosome, gene, nucleotide

Ans. (4)

117. Which one of the following hormones though synthesised elsewhere, is stored and released by the master gland ?

- (1) Melanocyte stimulating hormone
 (2) Antidiuretic hormone
 (3) Luteinizing hormone
 (4) Prolactin

Ans. (2)

118. Read the different components from (a) to (d) in the list given below and tell the correct order of the components with reference to their arrangement from outer side to inner side in a woody dicot stem:

- (a) Secondary cortex
 (b) Wood
 (c) Secondary phloem
 (d) Phellem

The correct order is :

- (1) (d), (c), (a), (b) (2) (c), (d), (b), (a)
 (3) (a), (b), (d), (c) (4) (d), (a), (c), (b)

Ans. (4)

119. Which of the following joints would allow no movement ?

- (1) Ball and Socket joint
 (2) Fibrous joint
 (3) Cartilaginous joint
 (4) Synovial joint

Ans. (2)

120. Which one of the following is **not** applicable to RNA?

- (1) Chargaff's rule
 (2) Complementary base pairing
 (3) 5' phosphoryl and 3' hydroxyl ends
 (4) Heterocyclic nitrogenous bases

Ans. (1)

121. Doctors use stethoscope to hear the sound; produced during each cardiac cycle. The second sound is heard when :

- (1) AV node receives signal from SA node
 (2) AV valves open up
 (3) Ventricular walls vibrate due to gushing of blood from atria
 (4) Semilunar valves close down after the blood flows into vessels from ventricles

Ans. (4)

122. During ecological succession :

- (1) the changes lead to a community that is in near equilibrium with the environment and is called pioneer community
 (2) the gradual and predictable change in species composition occurs in a given area
 (3) the establishment of a new biotic community is very fast in its primary phase
 (4) the number and types of animals remain constant

Ans. (2)

123. In the following human pedigree, the filled symbols represent the affected individuals. Identify the type of given pedigree.

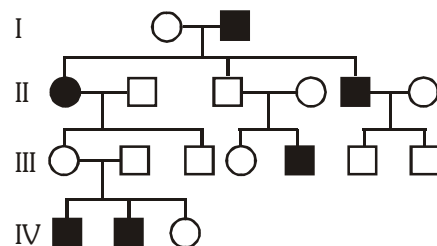

- (1) X-linked dominant
 (2) Autosomal dominant
 (3) X-linked recessive
 (4) Autosomal recessive

Ans. (4)

- 124.** Balbiani rings are sites of :
 (1) RNA and protein synthesis
 (2) Lipid synthesis
 (3) Nucleotide synthesis
 (4) Polysaccharide synthesis

Ans. (1)

- 125.** Name the pulmonary disease in which alveolar surface area involved in gas exchange is drastically reduced due to damage in the alveolar walls :
 (1) Asthma (2) Pleurisy
 (3) Emphysema (4) Pneumonia

Ans. (3)

- 126.** Which the following are most suitable indicator of SO₂ pollution in the environment ?
 (1) Fungi (2) Lichens
 (3) Conifers (4) Algae

Ans. (2)

- 127.** Satellite DNA is important because it :
 (1) Codes for enzymes needed for DNA replication
 (2) Codes for proteins needed in cell cycle
 (3) Shows high degree of polymorphism in population and also the same degree of polymorphism in an individual, which is heritable from parents to children
 (4) Does not code for proteins and is same in all members of the population

Ans. (3)

- 128.** Industrial melanism is an example of :
 (1) Neo Lamarckism (2) Neo Darwinism
 (3) Natural selection (4) Mutation

Ans. (3)

- 129.** A column of water within xylem vessels of tall trees does **not** break under its weight because of :
 (1) Positive root pressure
 (2) Dissolved sugars in water
 (3) Tensile strength of water
 (4) Lignification of xylem vessels

Ans. (3)

- 130.** The introduction of t-DNA into plants involves :
 (1) Allowing the plant roots to stand in water
 (2) Infection of the plant by *Agrobacterium tumefaciens*
 (3) Altering the pH of the soil, then heat shocking the plants
 (4) Exposing the plants to cold for a brief period

Ans. (2)

- 131.** Pick up the **wrong** statement :

- (1) Nuclear membrane is present in Monera
 (2) Cell wall is absent in Animalia
 (3) Protista have photosynthetic and heterotrophic modes of nutrition
 (4) Some fungi are edible

Ans. (1)

- 132.** In photosynthesis, the light-independent reactions take place at :
 (1) Stromal matrix
 (2) Thylakoid lumen
 (3) Photosystem - I
 (4) Photosystem-II

Ans. (1)

- 133.** Which of the following immunoglobulins does constitute the largest percentage in human milk?
 (1) IgG (2) IgD
 (3) IgM (4) IgA

Ans. (4)

- 134.** Which of the following pairs is **not** correctly matched?

	Mode of reproduction	Example
(1)	Conidia	<i>Penicillium</i>
(2)	Offset	Water hyacinth
(3)	Rhizome	Banana
(4)	Binary fission	<i>Sargassum</i>

Ans. (4)

- 135.** The UN conference of Parties on climate change in the year 2012 was held at :
 (1) Warsaw (2) Durban
 (3) Doha (4) Lima

Ans. (3)

136. In the spectrum of hydrogen, the ratio of the longest wavelength in the Lyman series to the longest wavelength in the Balmer series is :

- (1) $\frac{5}{27}$ (2) $\frac{4}{9}$ (3) $\frac{9}{4}$ (4) $\frac{27}{5}$

Ans. (1)

Sol. For Lyman series

$$\left(\frac{1}{\lambda_{\max}}\right)_L = R(1)^2 \left[\frac{1}{(1)^2} - \frac{1}{(2)^2} \right]$$

$$(\lambda_{\max})_L = \frac{4}{3R}$$

For Balmer series

$$\left(\frac{1}{\lambda_{\max}}\right)_B = R(1)^2 \left[\frac{1}{(2)^2} - \frac{1}{(3)^2} \right]$$

$$(\lambda_{\max})_B = \frac{36}{5R}$$

$$\frac{(\lambda_{\max})_L}{(\lambda_{\max})_B} = \frac{4}{3R} \times \frac{5R}{36} = \frac{5}{27}$$

137. The energy of the em waves is of the order of 15 keV. To which part of the spectrum does it belong?

- (1) γ -rays (2) X-rays
(3) Infra-red rays (4) Ultraviolet rays

Ans. (2)

Sol. Wavelength of the ray

$$\lambda = \frac{hc}{E}$$

$$= 0.826 \text{ \AA}$$

since $\lambda < 100 \text{ \AA}$

so it is X-ray

138. An electron moves on a straight line path XY as shown. The abcd is a coil adjacent to the path of electron. What will be the direction of current, if any, induced in the coil ?

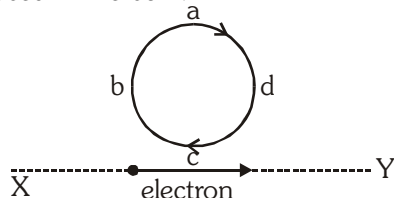

- (1) No current induced
(2) abcd
(3) adcb
(4) The current will reverse its direction as the electron goes past the coil

Ans. (4)

Sol. First current develops in direction of abcd but when electron moves away, then magnetic field inside loop decreases & current changes its direction.

139. The cylindrical tube of a spray pump has radius R, one end of which has n fine holes, each of radius r. If the speed of the liquid in the tube is V, the speed of the ejection of the liquid through the holes is :

- (1) $\frac{V^2R}{nr}$ (2) $\frac{VR^2}{n^2r^2}$
(3) $\frac{VR^2}{nr^2}$ (4) $\frac{VR^2}{n^3r^2}$

Ans. (3)



Sol.

$$Av = \text{constant}$$

$$\pi R^2 V = n \pi r^2 v_1$$

$$\Rightarrow v_1 = \frac{VR^2}{nr^2}$$

140. The Young's modulus of steel is twice that of brass.

Two wires of same length and of same area of cross section, one of steel and another of brass are suspended from the same roof. If we want the lower ends of the wires to be at the same level, then the weights added to the steel and brass wires must be in the ratio of :

- (1) 1 : 1 (2) 1 : 2 (3) 2 : 1 (4) 4 : 1

Ans. (3)

Sol. $Y = \frac{F\ell}{A\Delta\ell} \Rightarrow \Delta\ell = \frac{F\ell}{AY}$

$$(\Delta\ell)_{\text{steel}} = (\Delta\ell)_{\text{brass}}$$

$$\Rightarrow \frac{W_s \ell}{AY_s} = \frac{W_B \ell}{AY_B}$$

$$\Rightarrow \frac{W_s}{W_B} = \frac{Y_s}{Y_B} = 2$$

141. A potentiometer wire of length L and a resistance r are connected in series with a battery of e.m.f. E_0 and a resistance r_1 . An unknown e.m.f. E is balanced at a length ℓ of the potentiometer wire. The e.m.f. E will be given by :

- (1) $\frac{LE_0 r}{(r+r_1)\ell}$ (2) $\frac{LE_0 r}{\ell r_2}$
(3) $\frac{E_0 r}{(r+r_1)} \cdot \frac{\ell}{L}$ (4) $\frac{E_0 \ell}{L}$

Ans (3)

Sol. Potential gradient $x = \frac{ir}{L} = \frac{E_0}{(r_1+r)} \cdot \frac{r}{L}$

$$\therefore \text{e.m.f. } E = x\ell = \frac{E_0 r}{(r+r_1)} \cdot \frac{r}{L}$$

142. A particle is executing a simple harmonic motion. Its maximum acceleration is α and maximum velocity is β . Then, its time period of vibration will be :-

- (1) $\frac{2\pi\beta}{\alpha}$ (2) $\frac{\beta^2}{\alpha^2}$ (3) $\frac{\alpha}{\beta}$ (4) $\frac{\beta^2}{\alpha}$

Ans (1)

Sol. For S.H.M.

Maximum acceleration = $\omega^2 A = \alpha$

Maximum velocity = $\omega A = \beta$

$$\Rightarrow \omega = \frac{\alpha}{\beta} \Rightarrow T = \frac{2\pi}{\omega} = \frac{2\pi\beta}{\alpha}$$

143. If vectors $\vec{A} = \cos\omega t \hat{i} + \sin\omega t \hat{j}$ and

$\vec{B} = \cos\frac{\omega t}{2} \hat{i} + \sin\frac{\omega t}{2} \hat{j}$ are functions of time, then

the value of t at which they are orthogonal to each other is :

- (1) $t = 0$ (2) $t = \frac{\pi}{4\omega}$
 (3) $t = \frac{\pi}{2\omega}$ (4) $t = \frac{\pi}{\omega}$

Ans (4)

Sol. $\vec{A} \cdot \vec{B} = 0$

$$\cos \omega t \cos \frac{\omega t}{2} + \sin \omega t \sin \frac{\omega t}{2} = 0$$

$$\cos\left(\omega t - \frac{\omega t}{2}\right) = 0 \Rightarrow \cos\frac{\omega t}{2} = 0$$

$$\Rightarrow \frac{\omega t}{2} = \frac{\pi}{2} \Rightarrow t = \frac{\pi}{\omega}$$

144. A source of sound S emitting waves of frequency 100 Hz and an observer O are located at some distance from each other. The source is moving with a speed of 19.4 ms^{-1} at an angle of 60° with the source observer line as shown in the figure. The observer is at rest. The apparent frequency observed by the observer (velocity of sound in air 330 ms^{-1}) is :-

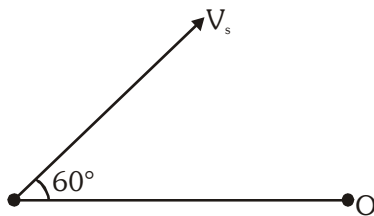

- (1) 97 Hz (2) 100 Hz (3) 103 Hz (4) 106 Hz

Ans. (3)

Sol. $f_0 = f_s \left(\frac{v}{v - v_s} \right) = 100 \left(\frac{330}{330 - \frac{19.4}{2}} \right) \approx 103 \text{ Hz}$

145. An automobile moves on a road with a speed of 54 kmh^{-1} . The radius of its wheels is 0.45 m and the moment of inertia of the wheel about its axis of rotation is 3 kgm^2 . If the vehicle is brought to rest in 15s, the magnitude of average torque transmitted by its brakes to wheel is :-

- (1) $2.86 \text{ kg m}^2\text{s}^{-2}$
 (2) $6.66 \text{ kg m}^2\text{s}^{-2}$
 (3) $8.58 \text{ kg m}^2\text{s}^{-2}$
 (4) $10.86 \text{ kg m}^2\text{s}^{-2}$

Ans. (2)

Sol. Velocity of the automobile

$$v = 54 \times \frac{5}{18} = 15 \text{ m/s}$$

$$\omega_0 = \frac{v}{R} = \frac{15}{0.45} = \frac{100}{3} \text{ rad/s}$$

so angular acceleration

$$\alpha = \frac{\Delta\omega}{t} = \frac{\omega_f - \omega_0}{t} = -\frac{100}{45} \text{ rad/s}^2$$

$$\text{so Torque} = I\alpha = 3 \times \frac{100}{45} = 6.66 \text{ kg-m}^2\text{s}^{-2}$$

146. A rectangular coil of length 0.12 m and width 0.1 m having 50 turns of wire is suspended vertically in a uniform magnetic field of strength 0.2 Weber/m^2 . The coil carries a current of 2 A. If the plane of the coil is inclined at an angle of 30° with the direction of the field, the torque required to keep the coil in stable equilibrium will be :

- (1) 0.12 Nm (2) 0.15 Nm
 (3) 0.20 Nm (4) 0.24 Nm

Ans (3)

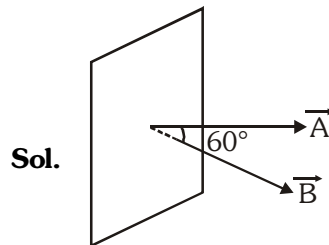

$$\vec{\tau} = \vec{M} \times \vec{B}$$

$$|\vec{\tau}| = MB \sin \theta = NIAB \sin \theta = 0.20 \text{ Nm}$$

147. A parallel plate air capacitor has capacity 'C' distance of separation between plates is 'd' and potential difference 'V' is applied between the plates force of attraction between the plates of the parallel plate air capacitor is :

- (1) $\frac{C^2V^2}{2d^2}$ (2) $\frac{C^2V^2}{2d}$ (3) $\frac{CV^2}{2d}$ (4) $\frac{CV^2}{d}$

Ans. (3)

Sol. $F = \frac{Q^2}{2\epsilon_0 A}$

$\therefore Q = CV$ and $C = \frac{\epsilon_0 A}{d} \Rightarrow \epsilon_0 A = Cd$

So $F = \frac{C^2V^2}{2Cd} = \frac{CV^2}{2d}$

148. Two vessels separately contain two ideal gases A and B at the same temperature, the pressure of A being twice that of B. Under such conditions, the density of A is found to be 1.5 times the density of B. The ratio of molecular weight of A and B is :

- (1) $\frac{1}{2}$ (2) $\frac{2}{3}$
(3) $\frac{3}{4}$ (4) 2

Ans. (3)

Sol. According to ideal gas equation

$P = \frac{\rho RT}{M} \Rightarrow M = \frac{\rho RT}{P}$

so $\frac{M_A}{M_B} = \frac{\rho_A}{\rho_B} \cdot \frac{T_A}{T_B} \cdot \frac{P_B}{P_A} = (1.5) (1) \left(\frac{1}{2}\right)$

$\Rightarrow \frac{M_A}{M_B} = \frac{3}{4}$

149. A satellite S is moving in an elliptical orbit around the earth. The mass of the satellite is very small compared to the mass of the earth. Then,

- (1) the acceleration of S is always directed towards the centre of the earth.
- (2) the angular momentum of S about the centre of the earth changes in direction, but its magnitude remains constant.
- (3) the total mechanical energy of S varies periodically with time.
- (4) the linear momentum of S remains constant in magnitude.

Ans. (1)

150. In the given figure, a diode D is connected to an external resistance $R = 100 \Omega$ and an e.m.f of 3.5V. If the barrier potential developed across the diode is 0.5 V, the current in the circuit will be :

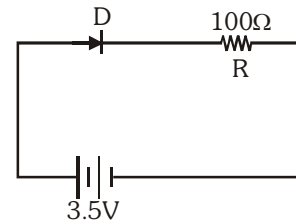

- (1) 35 mA (2) 30 mA
(3) 40 mA (4) 20 mA

Ans. (2)

Sol. Potential difference on R = 3.5 - 0.5 = 3.0 volt

Current in circuit $i = \frac{V}{R} = \frac{3}{100} = 30\text{mA}$

151. A remote - sensing satellite of earth revolves in a circular orbit at a height of 0.25×10^6 m above the surface of earth. If earth's radius is 6.38×10^6 m and $g=9.8 \text{ ms}^{-2}$, then the orbital speed of the satellite is :

- (1) 6.67 km s^{-1} (2) 7.76 km s^{-1}
(3) 8.56 km s^{-1} (4) 9.13 km s^{-1}

Ans. (2)

Sol. For the satellite revolving around earth

$v_0 = \sqrt{\frac{GM_e}{(R_e + h)}} = \sqrt{\frac{GM_e}{R_e \left(1 + \frac{h}{R_e}\right)}} = \sqrt{\frac{gR_e}{1 + \frac{h}{R_e}}}$

substituting the values

$v_0 = \sqrt{60 \times 10^6} \text{ m/s}$

$v_0 = 7.76 \times 10^3 \text{ m/s} = 7.76 \text{ km/s}$

152. The position vector of a particle \vec{R} as a function of time is given by :-

$\vec{R} = 4 \sin(2\pi t)\hat{i} + 4 \cos(2\pi t)\hat{j}$

Where R is in meters, t is in seconds and \hat{i} and \hat{j} denote unit vectors along x and y-directions, respectively. Which one of the following statements is wrong for the motion of particle ?

- (1) Path of the particle is a circle of radius 4 meter
- (2) Acceleration vectors is along $-\vec{R}$
- (3) Magnitude of acceleration vector is $\frac{v^2}{R}$ where v is the velocity of particle.
- (4) Magnitude of the velocity of particle is 8 meter/second

Ans. (4)

Sol. $\vec{R} = 4\sin(2\pi t)\hat{i} + 4\cos 2\pi t\hat{j}$

$$\vec{v} = \frac{d\vec{R}}{dt} = 8\pi \cos 2\pi t\hat{i} - 8\pi \sin 2\pi t\hat{j}$$

$$|\vec{v}| = 8\pi\sqrt{2}$$

153. A string is stretched between fixed points separated by 75.0 cm. It is observed to have resonant frequencies of 420 Hz and 315 Hz. There are no other resonant frequencies between these two. The lowest resonant frequencies for this string is :

- (1) 105 Hz (2) 155 Hz
 (3) 205 Hz (4) 10.5 Hz

Ans. (1)

Sol. Two consecutive resonant frequencies for a string fixed at both ends will be

$$\frac{nv}{2\ell} \text{ and } \frac{(n+1)v}{2\ell}$$

$$\Rightarrow \frac{(n+1)v}{2\ell} - \frac{nv}{2\ell} = 420 - 315$$

$$\frac{v}{2\ell} = 105 \text{ Hz}$$

Which is the minimum resonant frequency

154. Point masses m_1 and m_2 are placed at the opposite ends of a rigid rod of length L , and negligible mass. The rod is to be set rotating about an axis perpendicular to it. The position of point P on this rod through which the axis should pass so that the work required to set the rod rotating with angular velocity ω_0 is minimum, is given by :-

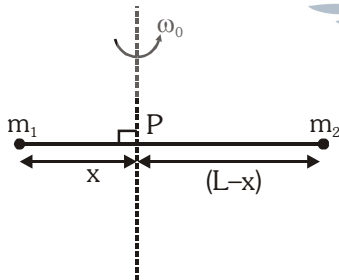

- (1) $x = \frac{m_2 L}{m_1 + m_2}$ (2) $x = \frac{m_1 L}{m_1 + m_2}$
 (3) $x = \frac{m_1 L}{m_2}$ (4) $x = \frac{m_2 L}{m_1}$

Ans. (1)

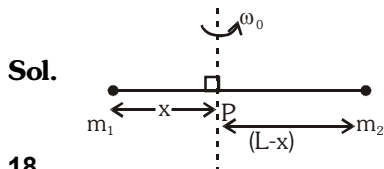

The position of point P on rod through which the axis should pass so that the work required to set the rod rotating with minimum angular velocity ω_0 is their centre of mass

$$\text{so } m_1 x = m_2 (L-x) \Rightarrow x = \frac{m_2 L}{m_1 + m_2}$$

155. At the first minimum adjacent to the central maximum of a single-slit diffraction pattern the phase difference between the Huygen's wavelet from the edge of the slit and the wavelet from the mid point of the slit is :-

- (1) $\frac{\pi}{8}$ radian (2) $\frac{\pi}{4}$ radian
 (3) $\frac{\pi}{2}$ radian (4) π radian

Ans. (4)

Sol.

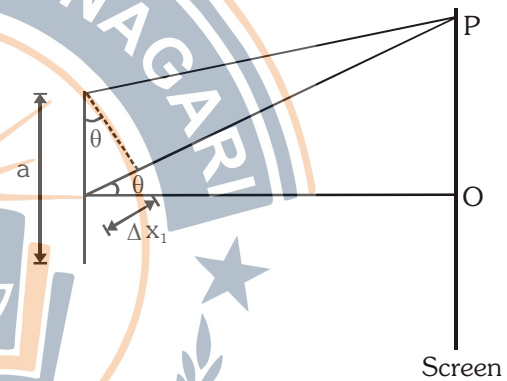

For first minima at P, $a \sin \theta = \lambda$

So phase difference $\Delta\phi_1 = \frac{\Delta x_1}{\lambda} \times 2\pi$

$$= \frac{(a/2) \sin \theta}{\lambda} \times 2\pi$$

$$\Delta\phi_1 = \frac{\lambda}{2\lambda} \times 2\pi = \pi \text{ radian}$$

156. A force $\vec{F} = \alpha\hat{i} + 3\hat{j} + 6\hat{k}$ is acting at a point $\vec{r} = 2\hat{i} - 6\hat{j} - 12\hat{k}$. The value of α for which angular momentum about origin is conserved is :

- (1) 1 (2) -1
 (3) 2 (4) zero

Ans. (2)

Sol. For conservation of angular momentum about origin

$$\sum \vec{\tau}_{\text{net}} = 0 \Rightarrow \vec{r} \times \vec{F} = 0 \Rightarrow \alpha = -1$$

157. Two particles A and B, move with constant velocities \vec{v}_1 and \vec{v}_2 . At the initial moment their position vectors are \vec{r}_1 and \vec{r}_2 respectively. The condition for particle A and B for their collision is :-

$$(1) \vec{r}_1 - \vec{r}_2 = \vec{v}_1 - \vec{v}_2 \quad (2) \frac{\vec{r}_1 - \vec{r}_2}{|\vec{r}_1 - \vec{r}_2|} = \frac{\vec{v}_2 - \vec{v}_1}{|\vec{v}_2 - \vec{v}_1|}$$

$$(3) \vec{r}_1 \cdot \vec{v}_1 = \vec{r}_2 \cdot \vec{v}_2 \quad (4) \vec{r}_1 \times \vec{v}_1 = \vec{r}_2 \times \vec{v}_2$$

Ans. (2)

Sol. For two particles to collide, the direction of the relative velocity of one with respect to other should be directed towards the relative position of the other particle

i.e. $\frac{\vec{r}_1 - \vec{r}_2}{|\vec{r}_1 - \vec{r}_2|} \rightarrow$ direction of relative position of 1 w.r.t. 2.

& $\frac{\vec{v}_2 - \vec{v}_1}{|\vec{v}_2 - \vec{v}_1|} \rightarrow$ direction of velocity of 2 w.r.t. 1

so for collision of A & B

$$\frac{\vec{r}_1 - \vec{r}_2}{|\vec{r}_1 - \vec{r}_2|} = \frac{\vec{v}_2 - \vec{v}_1}{|\vec{v}_2 - \vec{v}_1|}$$

158. A nucleus of uranium decays at rest into nuclei of thorium and helium. Then :-

- (1) The helium nucleus has less kinetic energy than the thorium nucleus
- (2) The helium has more kinetic energy than the thorium nucleus.
- (3) The helium nucleus has less momentum than the thorium nucleus.
- (4) The helium nucleus has more momentum than the thorium nucleus.

Ans. (2)

Sol. By COLM :

$$p_f = p_i = 0$$

$$\Rightarrow p_{\text{He}} - p_{\text{Th}} = 0 \Rightarrow p_{\text{He}} = p_{\text{Th}}$$

but $K \propto \frac{1}{m}$ and $m_{\text{He}} < m_{\text{Th}}$ So $K_{\text{He}} > K_{\text{Th}}$

159. Two metal wires of identical dimensions are connected in series. If σ_1 and σ_2 are the conductivities of the metal wires respectively, the effective conductivity of the combination is :-

$$(1) \frac{\sigma_1 \sigma_2}{\sigma_1 + \sigma_2} \quad (2) \frac{2\sigma_1 \sigma_2}{\sigma_1 + \sigma_2}$$

$$(3) \frac{\sigma_1 + \sigma_2}{2\sigma_1 \sigma_2} \quad (4) \frac{\sigma_1 + \sigma_2}{\sigma_1 \sigma_2}$$

Ans. (2)



$$R_{\text{eq}} = R_1 + R_2$$

$$\Rightarrow \frac{2l}{\sigma_{\text{eq}} A} = \frac{l}{\sigma_1 A} + \frac{l}{\sigma_2 A} \Rightarrow \sigma_{\text{eq}} = \frac{2\sigma_1 \sigma_2}{\sigma_1 + \sigma_2}$$

160. Light of wavelength 500 nm is incident on a metal with work function 2.28 eV. The de Broglie wavelength of the emitted electron is :-

- (1) $\leq 2.8 \times 10^{-12} \text{ m}$
- (2) $< 2.8 \times 10^{-10} \text{ m}$
- (3) $< 2.8 \times 10^{-9} \text{ m}$
- (4) $\geq 2.8 \times 10^{-9} \text{ m}$

Ans. (4)

Sol. Energy of photon $(E) = \frac{12400}{5000} = 2.48 \text{ eV}$

Work function $(\phi_0) = 2.28 \text{ eV}$

According to einstein equation

$$E = \phi_0 + (\text{K.E.})_{\text{max}}$$

$$\Rightarrow 2.48 = 2.28 + (\text{K.E.})_{\text{max}}$$

$$\Rightarrow (\text{K.E.})_{\text{max}} = 0.20 \text{ eV}$$

For electron $\lambda = \frac{h}{\sqrt{2mE}} \Rightarrow \lambda \approx 28 \text{ \AA}$

So $\lambda \geq 2.8 \times 10^{-9} \text{ m}$

161. 4.0 g of a gas occupies 22.4 litres at NTP. The specific heat capacity of the gas at constant volume is $5.0 \text{ JK}^{-1} \text{ mol}^{-1}$. If the speed of sound in this gas at NTP is 952 ms^{-1} , then the heat capacity at constant pressure is

(Take gas constant $R = 8.3 \text{ JK}^{-1} \text{ mol}^{-1}$)

- (1) $8.5 \text{ JK}^{-1} \text{ mol}^{-1}$
- (2) $8.0 \text{ JK}^{-1} \text{ mol}^{-1}$
- (3) $7.5 \text{ JK}^{-1} \text{ mol}^{-1}$
- (4) $7.0 \text{ JK}^{-1} \text{ mol}^{-1}$

Ans. (2)

Sol. Molecular mass $M = 4.0 \text{ g}$

$$v_{\text{sound}} = \sqrt{\frac{\gamma RT}{M}} \Rightarrow \gamma = \frac{M v^2}{RT} = 1.6$$

So, $C_p = \gamma C_v = 1.6 \times 5.0 = 8.0 \text{ J K}^{-1} \text{ mol}^{-1}$

162. A series R-C circuit is connected to an alternating voltage source. Consider two situations :-

- (a) When capacitor is air filled.
- (b) When capacitor is mica filled.

Current through resistor is i and voltage across capacitor is V then :-

- (1) $V_a = V_b$
- (2) $V_a < V_b$
- (3) $V_a > V_b$
- (4) $i_a > i_b$

Ans. (3)

Sol. When capacitor is filled with mica then capacitance C increases so X_C decreases

In case (b) $X_C \downarrow$ so voltage across capacitor decreases. so $V_a > V_b$

163. A plank with a box on it at one end is gradually raised about the other end. As the angle of inclination with the horizontal reaches 30° , the box starts to slip and slides 4.0 m down the plank in 4.0 s. The coefficients of static and kinetic friction between the box and the plank will be, respectively :

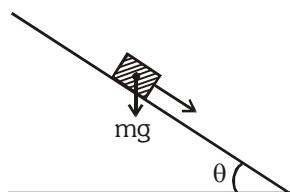

- (1) 0.4 and 0.3 (2) 0.6 and 0.6
 (3) 0.6 and 0.5 (4) 0.5 and 0.6

Ans. (3)

Sol. Coefficient of static friction,

$$\mu_s = \tan 30^\circ = \frac{1}{\sqrt{3}} = 0.6$$

$$a = g \sin 30^\circ - \mu_k g \cos 30^\circ$$

$$S = ut + \frac{1}{2}at^2$$

$$\Rightarrow 4 = \frac{1}{2} \left[\frac{g}{2} - \frac{\mu_k g \sqrt{3}}{2} \right] \times 16 \Rightarrow \mu_k = 0.5$$

164. Two stones of masses m and $2m$ are whirled in horizontal circles, the heavier one in a radius $\frac{r}{2}$ and the lighter one in radius r . The tangential speed of lighter stone is n times that of the value of heavier stone when they experience same centripetal forces. The value of n is :

- (1) 1 (2) 2 (3) 3 (4) 4

Ans. (2)

Sol. $(F_c)_{\text{heavier}} = (F_c)_{\text{lighter}}$

$$\Rightarrow \frac{2mV^2}{(r/2)} = \frac{m(nV)^2}{r} \Rightarrow n^2 = 4 \Rightarrow n = 2$$

165. The coefficient of performance of a refrigerator is 5. If the temperature inside freezer is -20°C , the temperature of the surroundings to which it rejects heat is :

- (1) 21°C (2) 31°C
 (3) 41°C (4) 11°C

Ans. (2)

Sol. Coefficient of performance of refrigerator

20

$$\text{COP} = \frac{T_L}{T_H - T_L}$$

Where $T_L \rightarrow$ lower Temperature
 & $T_H \rightarrow$ Higher Temperature

$$\text{So, } 5 = \frac{T_L}{T_H - T_L}$$

$$\Rightarrow T_H = \frac{6}{5} T_L = \frac{6}{5} (253) = 303.6 \text{ K}$$

166. An ideal gas is compressed to half its initial volume by means of several processes. Which of the process results in the maximum work done on the gas ?

- (1) Isothermal (2) Adiabatic
 (3) Isobaric (4) Isochoric

Ans. (2)

Sol.

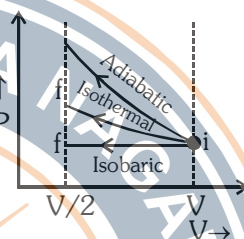

work done on the gas

$$W_{\text{isochoric}} = 0$$

and $W_{\text{adiabatic}} > W_{\text{isothermal}} > W_{\text{isobaric}}$

167. A ball is thrown vertically downwards from a height of 20 m with an initial velocity v_0 . It collides with the ground, loses 50 percent of its energy in collision and rebounds to the same height. The initial velocity v_0 is : (Take $g = 10 \text{ ms}^{-2}$)

- (1) 10 ms^{-1} (2) 14 ms^{-1}
 (3) 20 ms^{-1} (4) 28 ms^{-1}

Ans. (3)

Sol. Let ball rebounds with speed V so

$$v = \sqrt{2gh} = \sqrt{2 \times 10 \times 20} = 20 \text{ m/s}$$

Energy just after rebound

$$E = \frac{1}{2} \times m \times v^2 = 200 \text{ m}$$

50% energy loses in collision means just before collision energy is 400 m

By using energy conservation

$$\frac{1}{2}mv_0^2 + mgh = 400\text{m}$$

$$\Rightarrow \frac{1}{2}mv_0^2 + m \times 10 \times 20 = 400\text{m} \Rightarrow v_0 = 20 \text{ m/s}$$

168. On a frictionless surface, a block of mass M moving at speed v collides elastically with another block of same mass M which is initially at rest. After collision the first block moves at an angle θ to its initial direction and has a speed $\frac{v}{3}$. The second block's speed after the collision is :-

- (1) $\frac{\sqrt{3}}{2}v$ (2) $\frac{2\sqrt{2}}{3}v$ (3) $\frac{3}{4}v$ (4) $\frac{3}{\sqrt{2}}v$

Ans. (2)

Sol. In elastic collision energy of system remains same so.

$$(K.E)_{\text{before collision}} = (K.E)_{\text{After collision}}$$

Let speed of second body after collision is V'

$$\frac{1}{2}mv^2 + 0 = \frac{1}{2}m\left(\frac{v}{3}\right)^2 + \frac{1}{2}m(V')^2 \Rightarrow v' = \frac{2\sqrt{2}}{3}v$$

169. If potential (in volts) in a region is expressed as $V(x,y,z) = 6xy - y + 2yz$, the electric field (in N/C) at point $(1,1,0)$ is :-

- (1) $-(6\hat{i} + 9\hat{j} + \hat{k})$ (2) $-(3\hat{i} + 5\hat{j} + 3\hat{k})$
 (3) $-(6\hat{i} + 5\hat{j} + 2\hat{k})$ (4) $-(2\hat{i} + 3\hat{j} + \hat{k})$

Ans. (3)

Sol. $\vec{E} = -\frac{\partial V}{\partial x}\hat{i} - \frac{\partial V}{\partial y}\hat{j} - \frac{\partial V}{\partial z}\hat{k}$

$$\vec{E} = -(6y)\hat{i} - (6x - 1 + 2z)\hat{j} - (2y)\hat{k}$$

at point $(1,1,0)$

$$\vec{E} = -6\hat{i} - 5\hat{j} - 2\hat{k} = -(6\hat{i} + 5\hat{j} + 2\hat{k})$$

170. Two slits in Youngs experiment have widths in the ratio $1 : 25$. The ratio of intensity at the maxima

and minima in the interference pattern, $\frac{I_{\text{max}}}{I_{\text{min}}}$ is :

- (1) $\frac{4}{9}$ (2) $\frac{9}{4}$ (3) $\frac{121}{49}$ (4) $\frac{49}{121}$

Ans. (2)

Sol. $\frac{I_1}{I_2} = \frac{W_1}{W_2} = \frac{1}{25} \Rightarrow \frac{I_2}{I_1} = \frac{25}{1}$

$$\frac{I_{\text{max}}}{I_{\text{min}}} = \frac{(\sqrt{I_2} + \sqrt{I_1})^2}{(\sqrt{I_2} - \sqrt{I_1})^2} = \left(\frac{\sqrt{\frac{I_2}{I_1}} + 1}{\sqrt{\frac{I_2}{I_1}} - 1} \right)^2$$

$$= \left(\frac{5+1}{5-1} \right)^2 = \left(\frac{6}{4} \right)^2 = \frac{9}{4}$$

171. The heart of a man pumps 5 litres of blood through the arteries per minute at a pressure of 150 mm of mercury. If the density of mercury be $13.6 \times 10^3 \text{ kg/m}^3$ and $g = 10 \text{ m/s}^2$ then the power of heart in watt is: (1) 1.50 (2) 1.70 (3) 2.35 (4) 3.0

Ans. (2)

Sol. Pressure = 150 mm Hg

$$\text{Pumping rate} = \frac{dV}{dt} = \frac{5 \times 10^{-3}}{60} \text{ m}^3/\text{s}$$

$$\text{Power of heart} = P \cdot \frac{dV}{dt} = \rho gh \times \frac{dV}{dt}$$

$$= (13.6 \times 10^3 \text{ kg/m}^3) (10) \times (0.15) \times \frac{5 \times 10^{-3}}{60}$$

$$= \frac{13.6 \times 5 \times 0.15}{6} = 1.70 \text{ watt}$$

172. A proton and an alpha particle both enter a region of uniform magnetic field, B , moving at right angles to the field B . If the radius of circular orbits for both the particles is equal and the kinetic energy acquired by proton is 1 MeV, the energy acquired by the alpha particle will be :-

- (1) 1 MeV (2) 4 MeV
 (3) 0.5 MeV (4) 1.5 MeV

Ans. (1)

Sol. $R = \frac{mv}{qB} = \frac{\sqrt{2mK}}{qB}$

$$\therefore R_\alpha = R_p \quad \therefore \frac{4m_\alpha k_\alpha}{q_\alpha^2 B^2} = \frac{4m_p K_p}{q_p^2 B^2}$$

$$\Rightarrow \frac{4m_p k_\alpha}{4e^2} = \frac{m_p (1\text{MeV})}{e^2} \Rightarrow K_\alpha = 1\text{MeV}$$

173. The input signal given to a CE amplifier having a

voltage gain of 150 is $V_i = 2 \cos \left(15t + \frac{\pi}{3} \right)$. The corresponding output signal will be -

- (1) $300 \cos \left(15t + \frac{4\pi}{3} \right)$
 (2) $300 \cos \left(15t + \frac{\pi}{3} \right)$
 (3) $75 \cos \left(15t + \frac{2\pi}{3} \right)$
 (4) $2 \cos \left(15t + \frac{5\pi}{6} \right)$

Ans. (1)

Sol. Input signal $v_{in} = 2 \cos(15t + \frac{\pi}{3})$

Voltage Gain = 150

CE amplifier gives phase difference of π between input and output signals

$$A_v = \frac{V_0}{V_{in}} \text{ so } V_0 = A_v V_{in}$$

$$\text{so } V_0 = 150 \times 2 \cos(15t + \frac{\pi}{3} + \pi)$$

$$V_0 = 300 \cos(15t + \frac{4\pi}{3})$$

174. In dimension of critical velocity v_c , of liquid flowing through a tube are expressed as $(\eta^x \rho^y r^z)$, where η , ρ and r are the coefficient of viscosity of liquid, density of liquid and radius of the tube respectively, then the values of x , y and z are given by :

- (1) 1, 1, 1 (2) 1, -1, -1
 (3) -1, -1, 1 (4) -1, -1, -1

Ans. (2)

Sol. $v_c \propto [\eta^x \rho^y r^z]$

$$[L^1 T^{-1}] \propto [M^1 L^{-1} T^{-1}]^x [M^1 L^{-3}]^y [L^1]^z$$

$$[L^1 T^{-1}] \propto [M^{x+y} L^{-x-3y+z} T^{-x}]$$

taking comparison on both size

$$x + y = 0, -x - 3y + z = 1, -x = -1$$

$$\Rightarrow x = 1, y = -1, z = -1$$

175. A circuit contains an ammeter, a battery of 30 V and a resistance 40.8 ohm all connected in series. If the ammeter has a coil of resistance 480 ohm and a shunt of 20 ohm, the reading in the ammeter will be :-

- (1) 1 A (2) 0.5 A (3) 0.25 A (4) 2 A

Ans. (2)

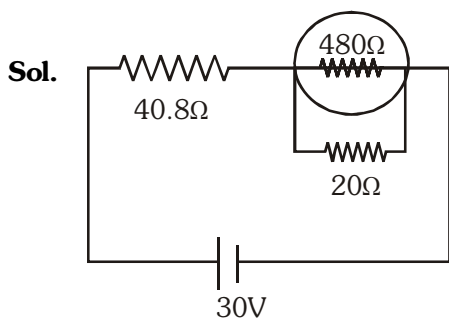

$$R_{eff} = 40.8 + \frac{480 \times 20}{480 + 20} = 40.8 + 19.2 = 60 \Omega$$

$$I = \frac{V_{eff}}{R_{eff}} = 0.5 A$$

176. Water rises to height 'h' in capillary tube. If the length of capillary tube above the surface of water is made less than 'h', then -

- (1) water does not rise at all.
 (2) water rises upto the tip of capillary tube and then starts overflowing like a fountain.
 (3) water rises upto the top of capillary tube and stays there without overflowing.
 (4) water rises upto a point a little below the top and stays there.

Ans. (3)

177. In an astronomical telescope in normal adjustment a straight black line of length L is drawn on inside part of objective lens. The eye-piece forms a real image of this line. The length of this image is I . The magnification of the telescope is :

- (1) $\frac{L}{I}$ (2) $\frac{L}{I} + 1$
 (3) $\frac{L}{I} - 1$ (4) $\frac{L+I}{L-I}$

Ans. (1)

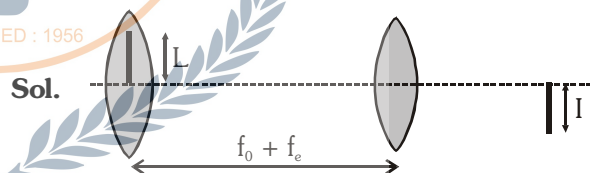

Sol. Magnification of telescope,

$$M = \frac{f_0}{f_e}$$

$$\text{Here } \frac{f_e}{f_e + u} = -\frac{I}{L}$$

$$\Rightarrow \frac{f_e}{f_e - (f_0 + f_e)} = -\frac{I}{L}$$

$$\Rightarrow \frac{f_e}{f_0} = \frac{I}{L}$$

$$\text{Therefore } M = \frac{L}{I}$$

178. The value of coefficient of volume expansion of glycerin is $5 \times 10^{-4} \text{ K}^{-1}$. The fractional change in the density of glycerin for a rise of 40°C in its temperature, is :-

- (1) 0.010
- (2) 0.015
- (3) 0.020
- (4) 0.025

Ans. (3)

Sol. $d_f = \frac{d_i}{(1 + \gamma\Delta T)}$

fractional change

$$\begin{aligned}
 &= \frac{d_i - d_f}{d_i} = 1 - \frac{d_f}{d_i} \\
 &= 1 - (1 + \gamma\Delta T)^{-1} \\
 &= 1 - (1 - \gamma\Delta T) \\
 &\because (1+x)^n \approx 1 + nx \\
 &= \gamma\Delta T \\
 &= 5 \times 10^{-4} \times 40 \\
 &= 0.020
 \end{aligned}$$

179. A photoelectric surface is illuminated successively by monochromatic light of wavelength λ and $\frac{\lambda}{2}$. If the maximum kinetic energy of the emitted photoelectrons in the second case is 3 times that in the first case, the work function of the surface of the material is :

(h = Planck's constant, c = speed of light)

- (1) $\frac{hc}{3\lambda}$
- (2) $\frac{hc}{2\lambda}$
- (3) $\frac{hc}{\lambda}$
- (4) $\frac{2hc}{\lambda}$

Ans. (2)

Sol. $KE_1 = \frac{hc}{\lambda} - \phi$

$$KE_2 = \frac{hc}{\lambda/2} - \phi = \frac{2hc}{\lambda} - \phi$$

$$KE_2 = 3KE_1$$

$$\Rightarrow \frac{2hc}{\lambda} - \phi = 3\left(\frac{hc}{\lambda} - \phi\right)$$

$$\Rightarrow 2\phi = \frac{hc}{\lambda}$$

$$\Rightarrow \phi = \frac{hc}{2\lambda}$$

180. A beam of light consisting of red, green and blue colours is incident on a right angled prism. The refractive index of the material of the prism for the above red, green and blue wavelengths are 1.39, 1.44 and 1.47, respectively.

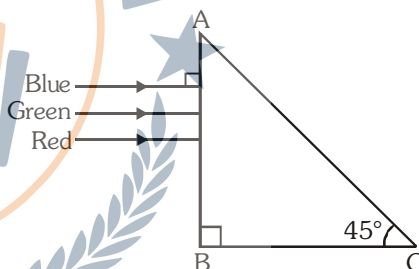

The prism will :-

- (1) separate the red colour part from the green and blue colours
- (2) separate the blue colour part from the red and green colours
- (3) separate all the three colours from one another
- (4) not separate the three colours at all

Ans. (1)

Sol. $\mu = \frac{1}{\sin i_c} = \frac{1}{\sin 45^\circ} = \sqrt{2} = 1.414$

$$\because (\mu_{\text{red}} = 1.39) < \mu, \mu_v > \mu; \mu_g > \mu$$

only red colour do not suffer total internal reflection.